

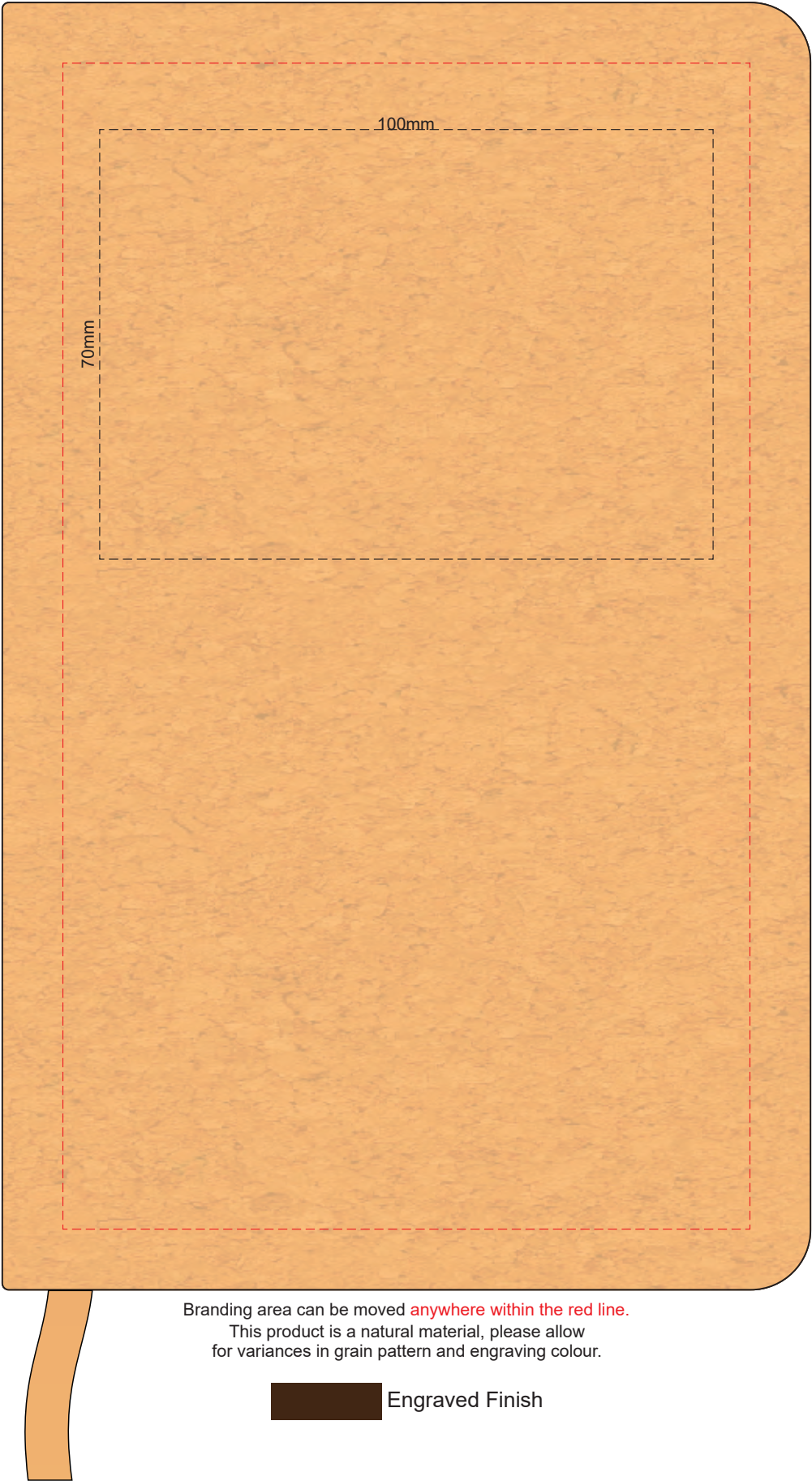

100% of Actual Size
Laser Engraving
FRONT



Branding area can be moved **anywhere within the red line.**
This product is a natural material, please allow
for variances in grain pattern and engraving colour.

 Engraved Finish

100% of Actual Size
Laser Engraving
BACK

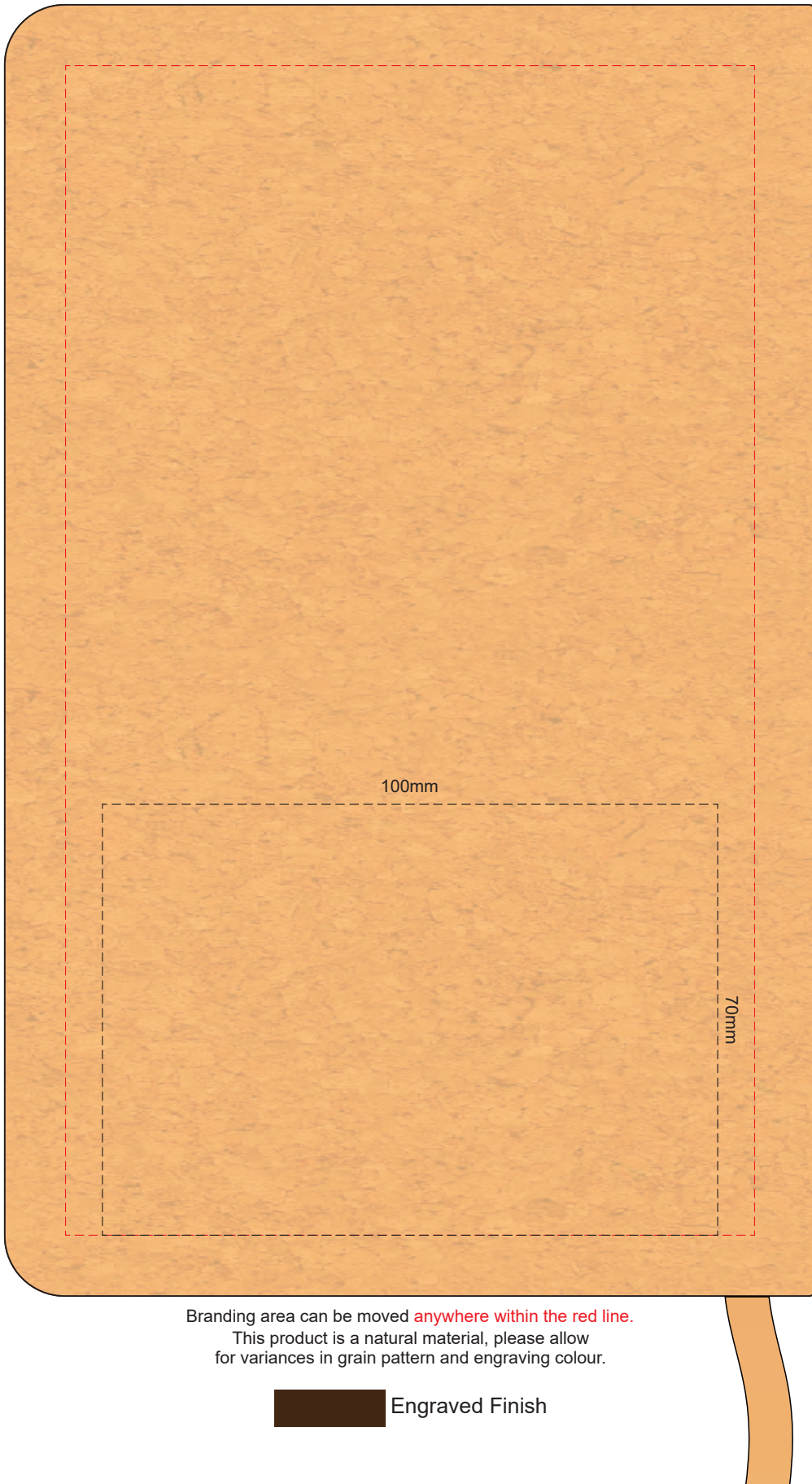

Branding area can be moved **anywhere within the red line.**
This product is a natural material, please allow
for variances in grain pattern and engraving colour.

 Engraved Finish

100% of Actual Size
Digital Print
FRONT

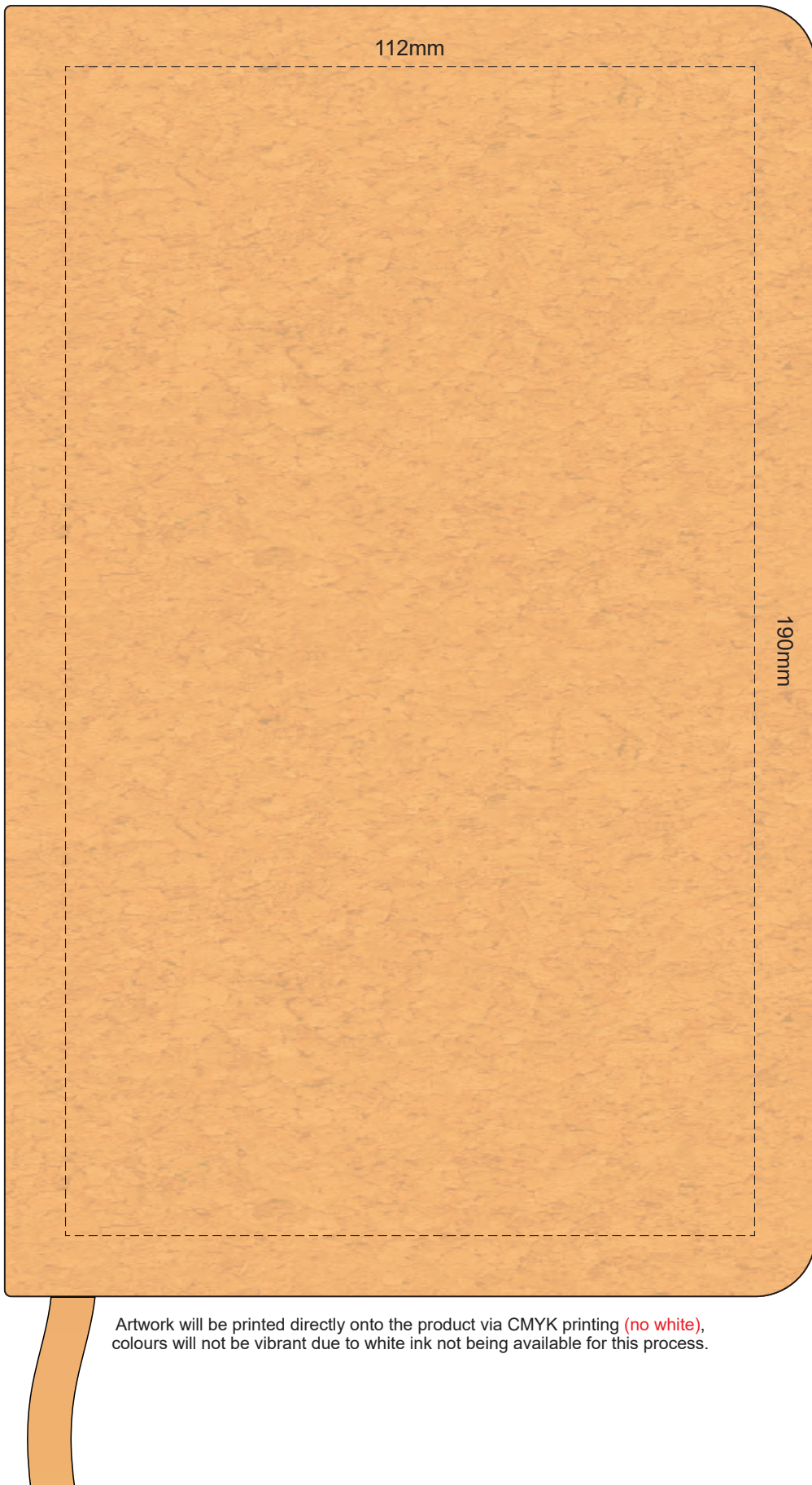

Artwork will be printed directly onto the product via CMYK printing (no white), colours will not be vibrant due to white ink not being available for this process.

100% of Actual Size
Digital Print
BACK

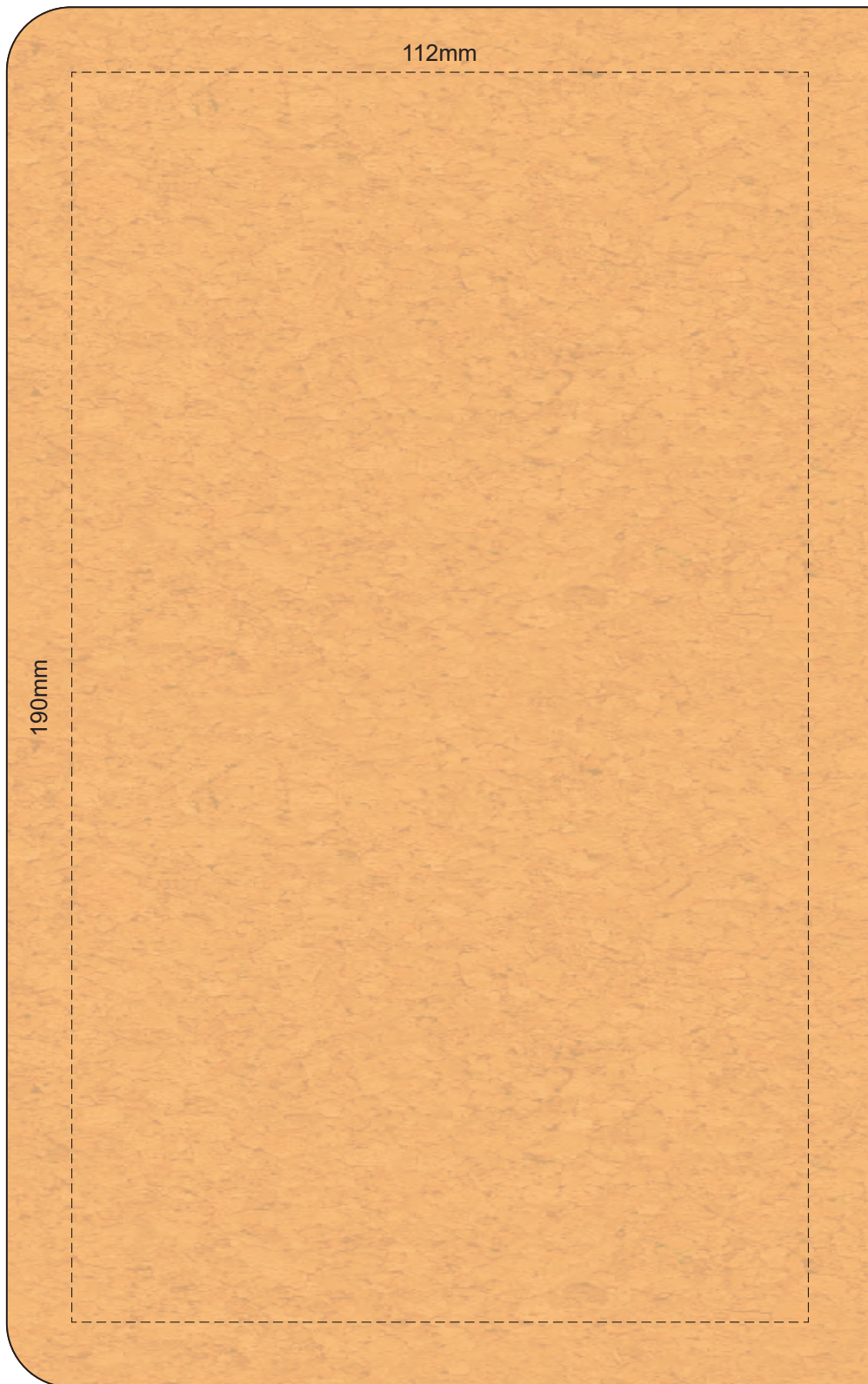

Artwork will be printed directly onto the product via CMYK printing (no white), colours will not be vibrant due to white ink not being available for this process.



70% of Actual Size
Digital Print - Belly Band Template

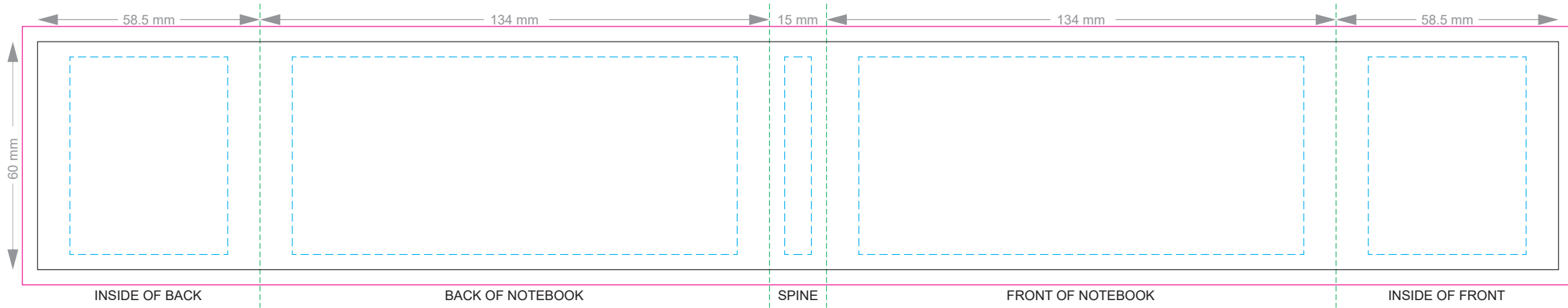

Artwork will be printed directly onto the product via CMYK printing (no white), colours will not be vibrant due to white ink not being available for this process

Green Line = Fold Lines when assembled on notebook

Blue Line = The SIGNIFICANT PRINT AREA

(Keep all critical images & text within this box)

Black Line = Maximum print area

Pink Line = Bleed off to here

25% of Actual Size

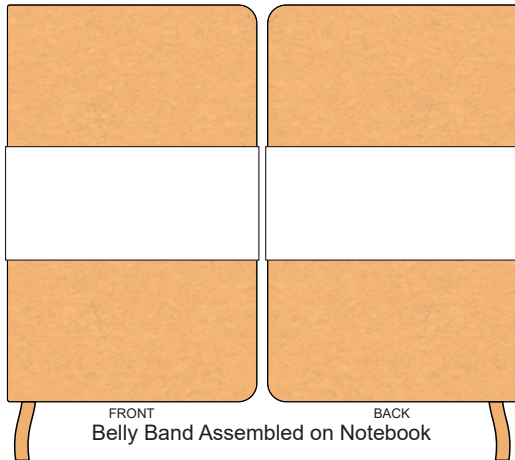

FRONT BACK
Belly Band Assembled on Notebook